

CODE: PET0185XV0206G01FE

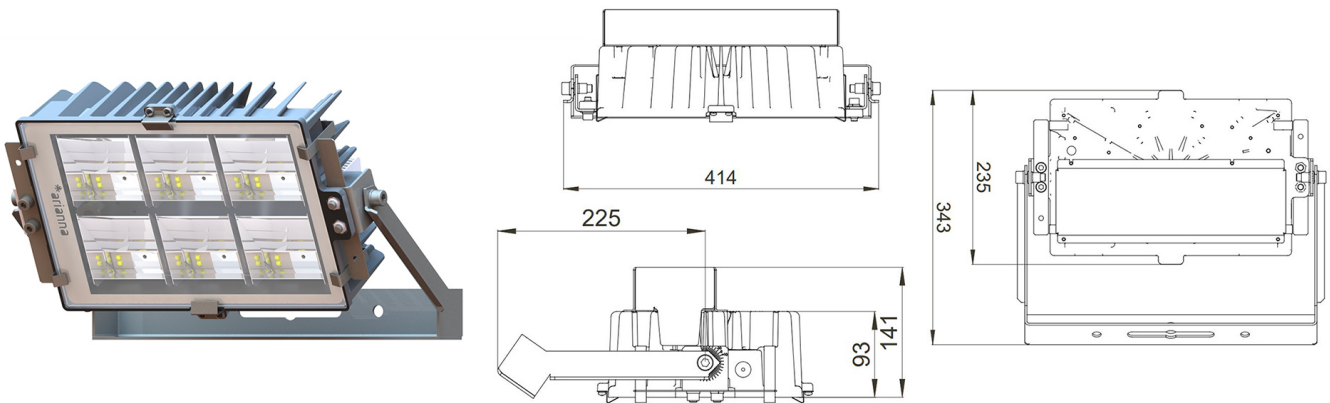

PRODUCT FEATURES

Voltage	220÷240 V ac
Frequency	50/60 Hz
Electrical safety class	II
Power supply	DMX
Driving current	525 mA
Service environment temperature	-30° ÷ +50° C
Storage room temperature	-40° ÷ +80° C
Certifications	ENEC, CE, RoHS, EN60598-1, EN60598-2-5
Surge protection	10 kV (10 kA max)

MECHANICAL FEATURES

Body	Die-cast aluminum EN AB 44300
Copper content	< 0,1%
Total weight with driver	8 Kg
Total weight without driver	5.8 Kg
Ingress protection	IP66
Shock protection	IK08
Diffuser	Glass tempered extra clear 4 mm
External screws	A2 stainless steel
Cable entry	Maximum diameter 14 mm
Mounting	Floodlight bracket

DRIVER FEATURES

Power factor (full-load)	> 0,90
Failure rate	< 10% at 100.000 h
Substitutability	External replaceable driver
Driver position	EXTERNAL
Flicker factor	< 3%

LED MODULE FEATURES

LED	Ceramic based power LED
Module Efficiency	up to 170 lm/W
Color temperature	4000 K
Color rendering index	> 80
L90B10	> 217.000 h
L90 (TM-21)	> 72.600 h
Optical system	Reflection optics

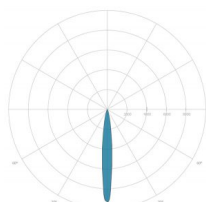

OPTICS: 6-ROTOSYMMETRICAL 10°

CODE	FLUX [lm]	POWER [W]	EFFICIENCY [lm/W]
PET0185XV0206G01FE	16830	153	110

Visit www.ariannaed.com for the complete list of certified products.

Flux and power data are corresponding to typical values referring to ambient temperature (Ta) equal to 25° C or 77° F with tolerance ± 7%.

In order to facilitate continuous updating of products Arianna spa reserves the right to make changes without notice.